

Bringing It All Together: ATTAINS Redesign and CWA 303(d) Measures “WQ-27 and WQ-28”

2015 NATIONAL TRAINING WORKSHOP ON
CWA 303(d) LISTING & TMDLS

SESSION #6 ATTAINS REDESIGN
APRIL 8, 2015

Overview of Presentation

- Data Model
 - Focus only on “Plans”
- Plan Data Entry
 - TMDL Data Entry (National TMDL Tracking System)
 - Alternatives Plan Data Entry (Not yet developed)
 - Protection Plan Entry (Not yet developed)
- Proposed changes to other EPA measures
- Where we are in the ATTAINS Redesign Effort

Data Model

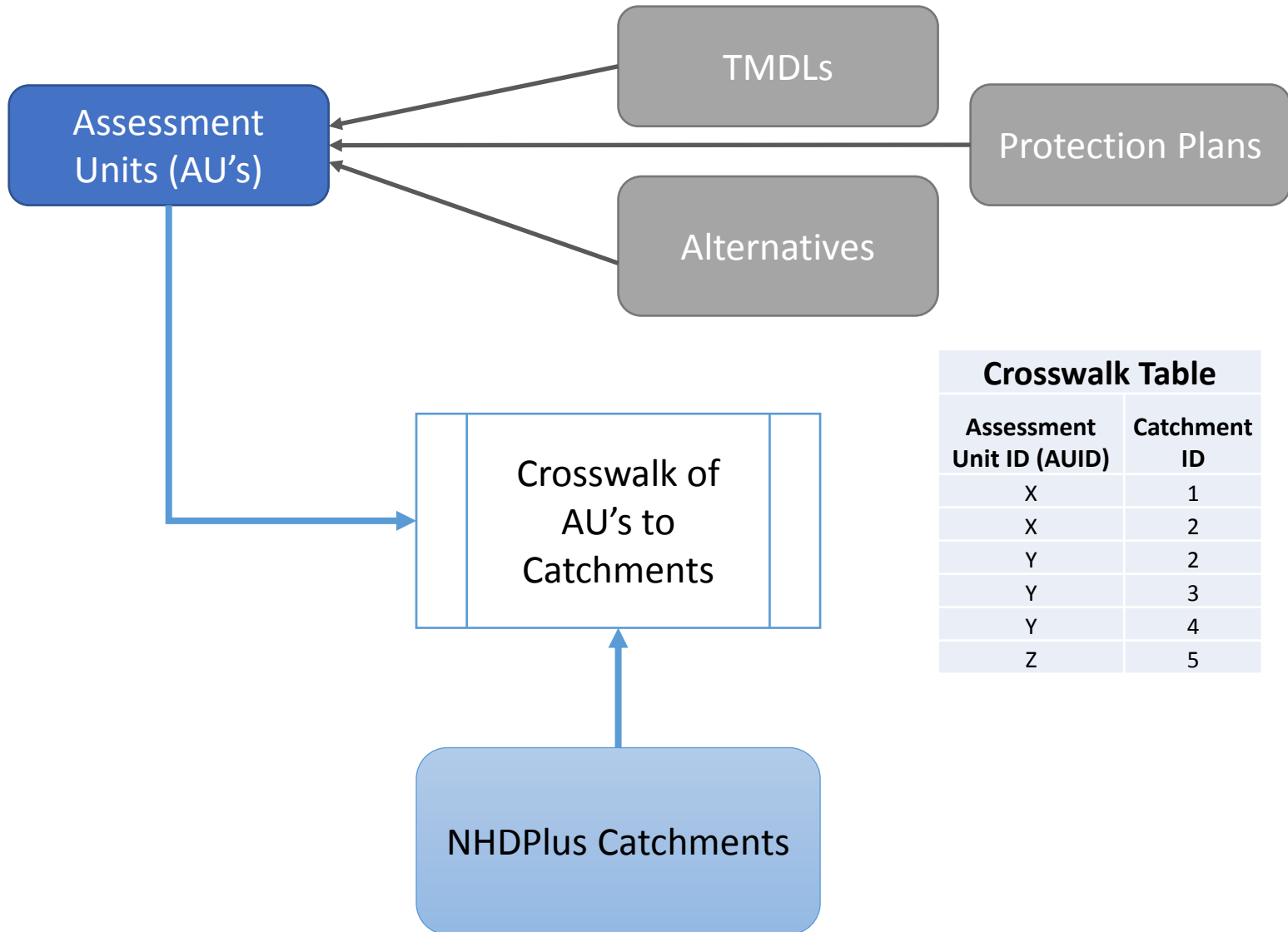

← Timing →

Now

Integrated Report

As Completed
"In Place"

Priorities

Assessment Units

Actions (Plans)

Assessments

Protection

TMDLs

Alternatives

303(d) list

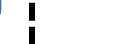

Define Priorities: Occurs once, or as needed when priorities change

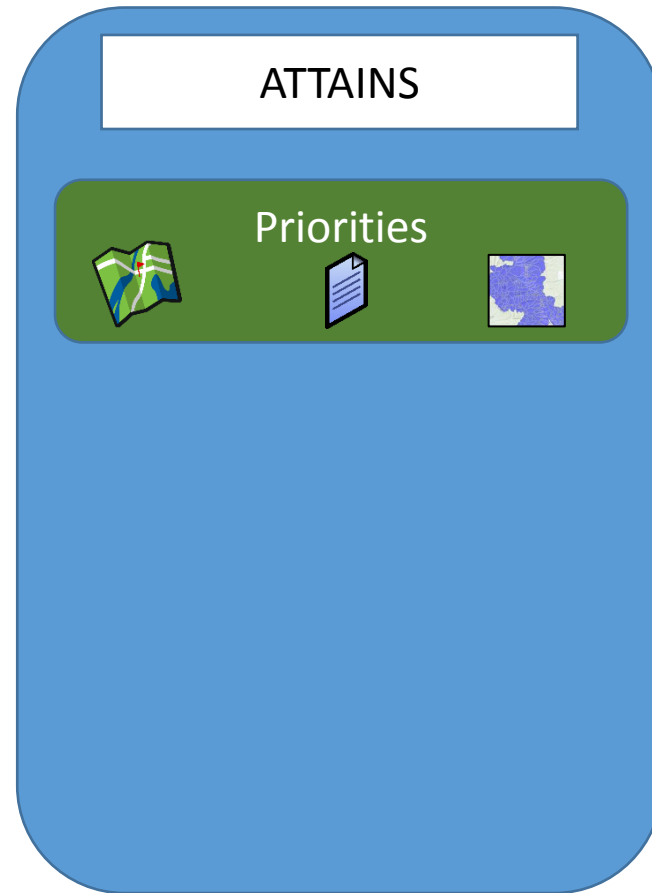
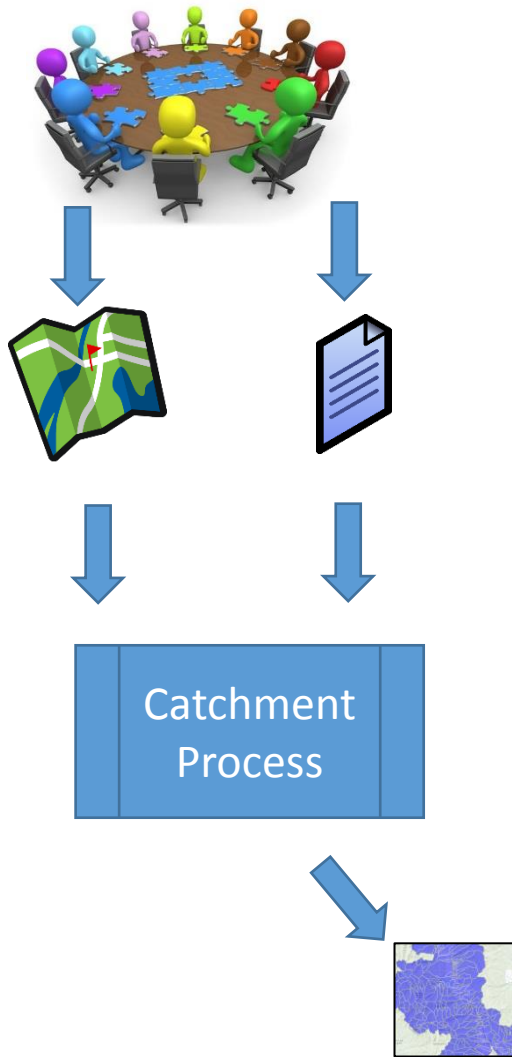



Define Assessment Units

Define Assessment Units: EPA will migrate most recent cycle's data and/or state provides every two years as part of the Integrated Report

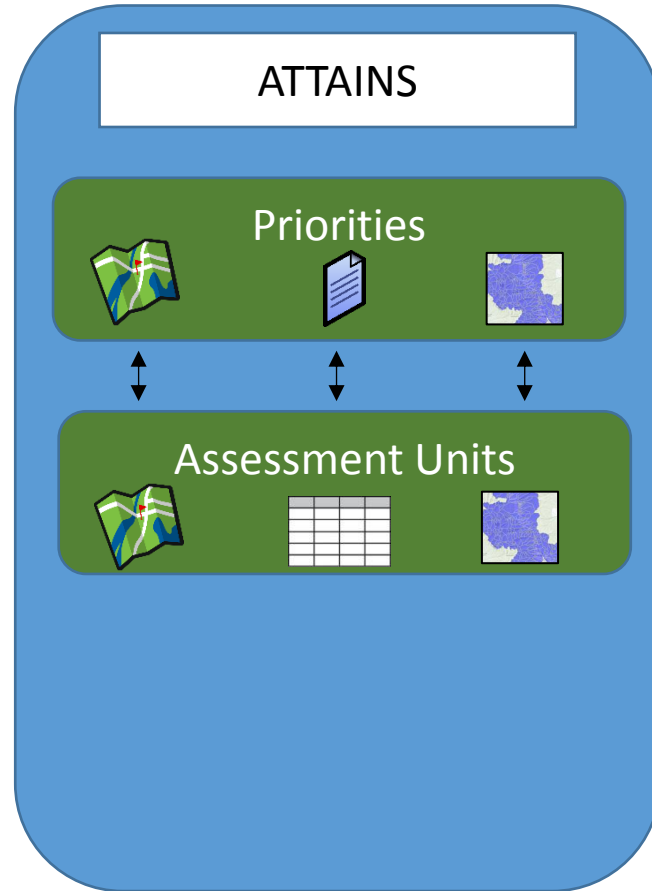
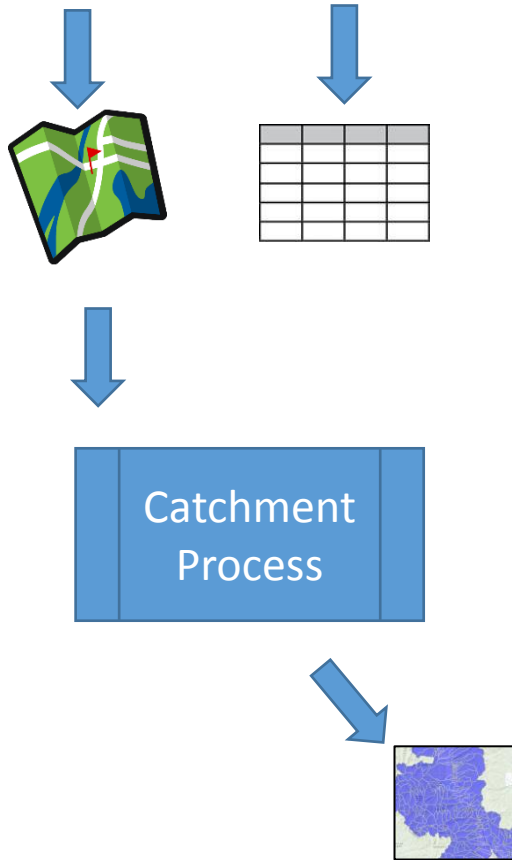

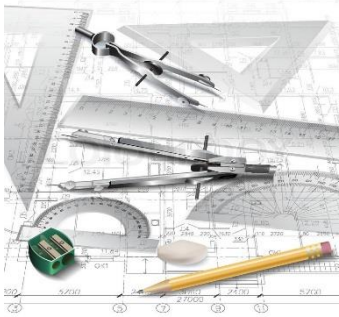

Putting Plans in Place: Plans are developed against Assessment Units and can address priorities

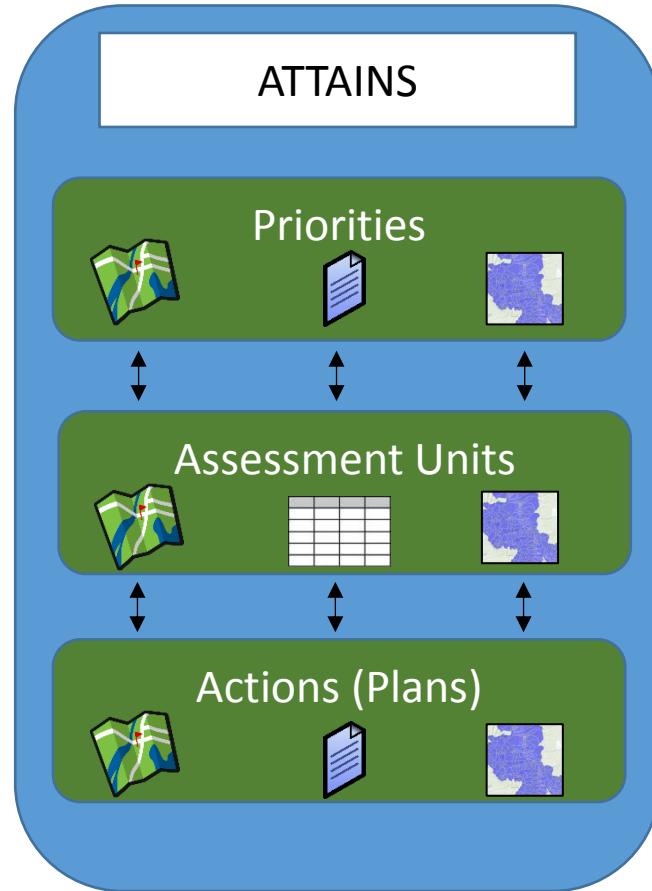
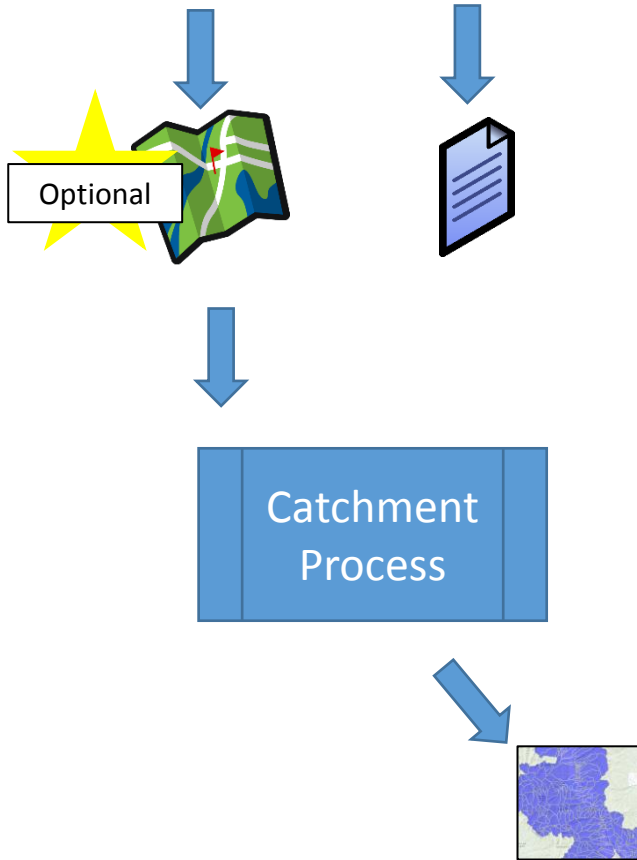

Calculating Measure: The measures are calculated based on the underlying data in ATTAINS

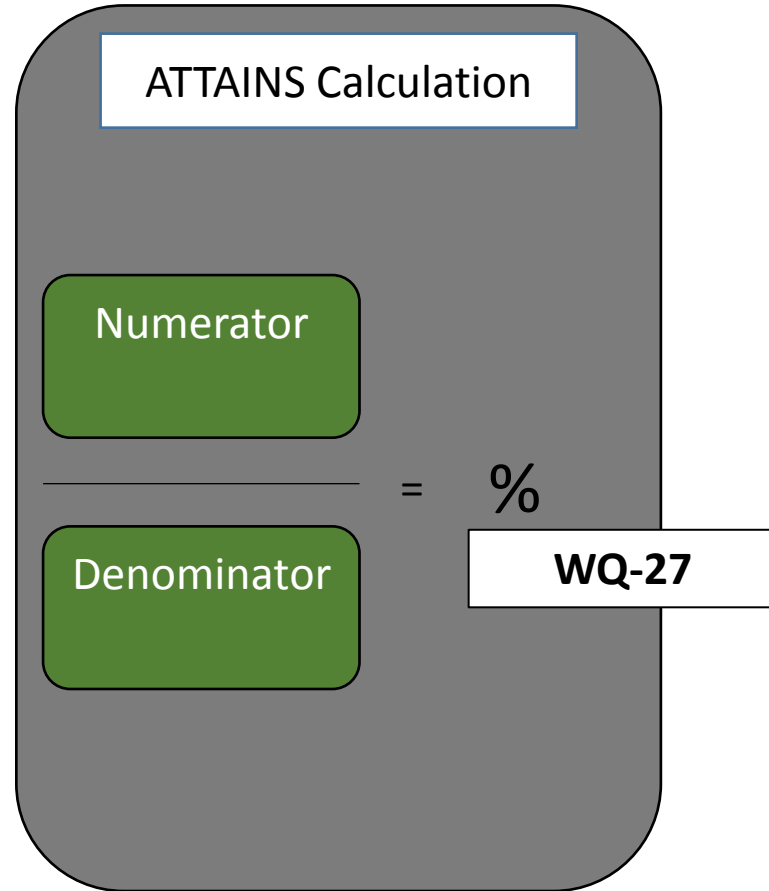
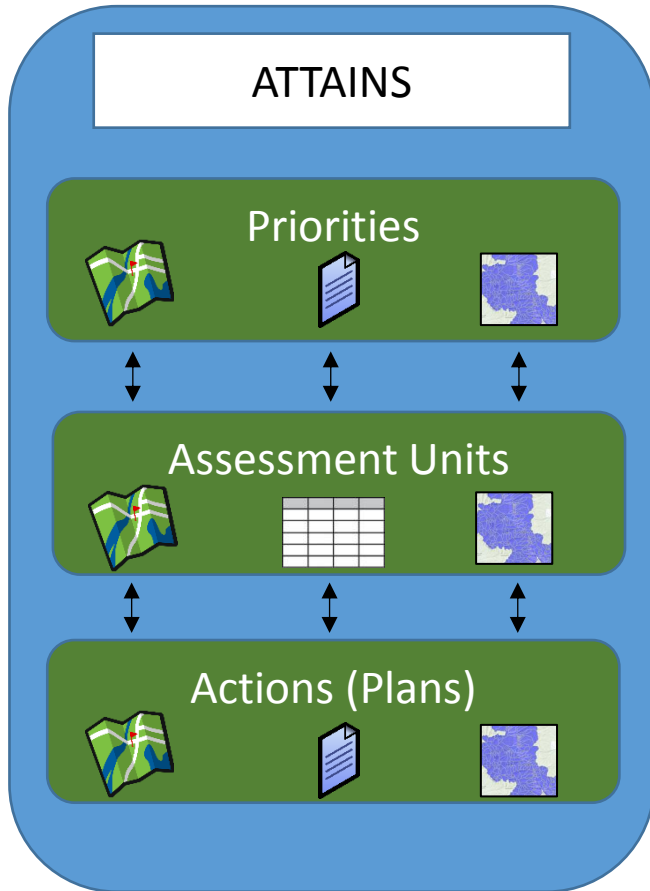

Entering Actions Into ATTAINS: Different types of plans will need different data elements. In all cases, a “plan” (i.e., document) should be included.

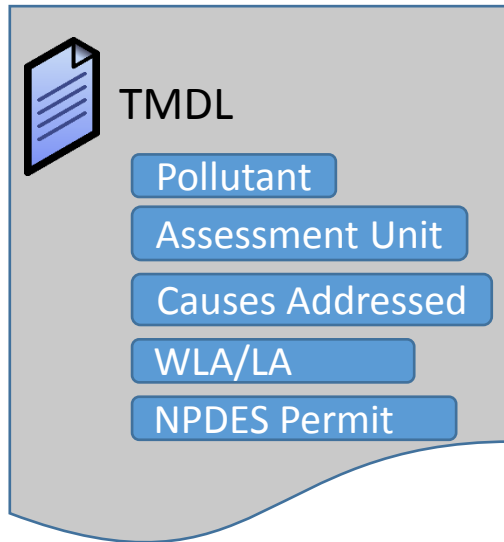

TMDL

- Pollutant
- Assessment Unit
- Causes Addressed
- WLA/LA
- NPDES Permit

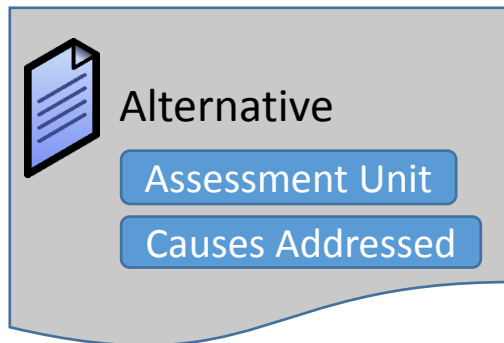

Alternative

- Assessment Unit
- Causes Addressed

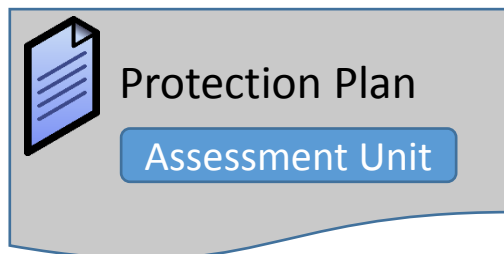

Protection Plan

- Assessment Unit

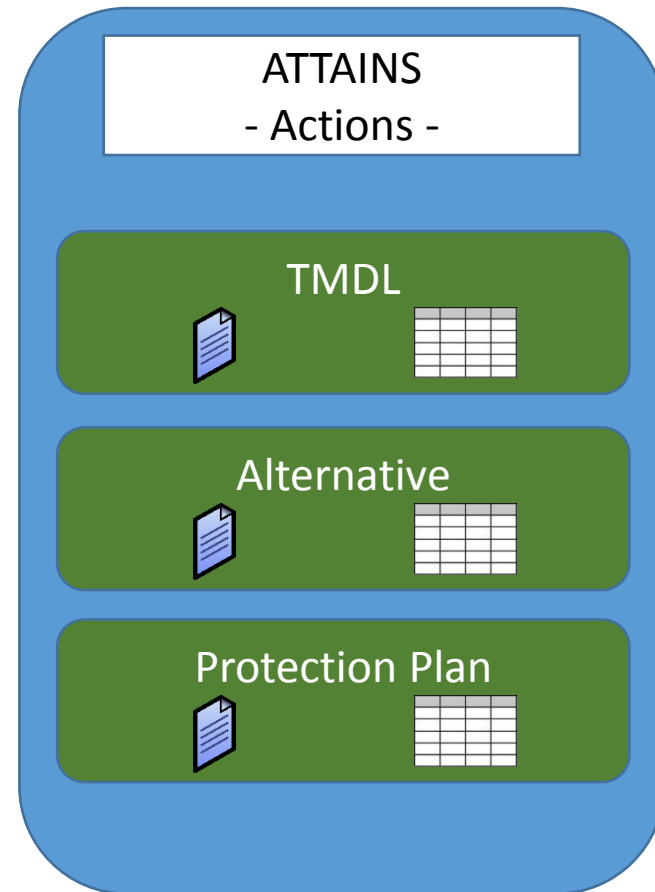

Action in Progress: Incremental progress can also be captured in ATTAINS. Identify the action (“planning” and “developing” under WQ-28), and associate the relevant Assessment Unit and Cause (for Protection plans, Cause is not required).

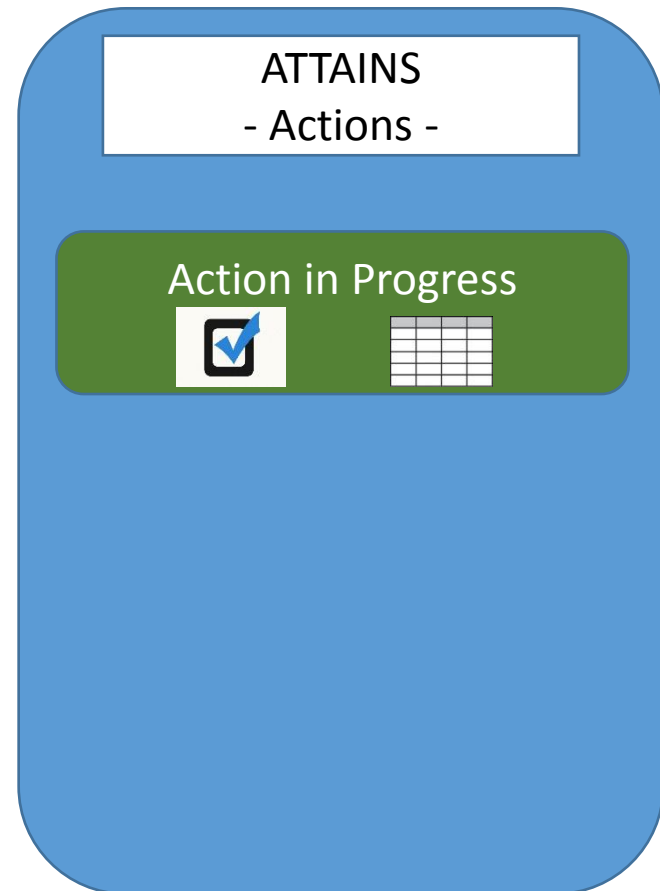
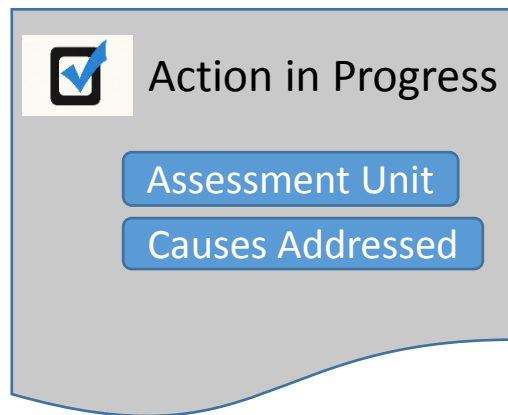

Proposed changes to other EPA measures

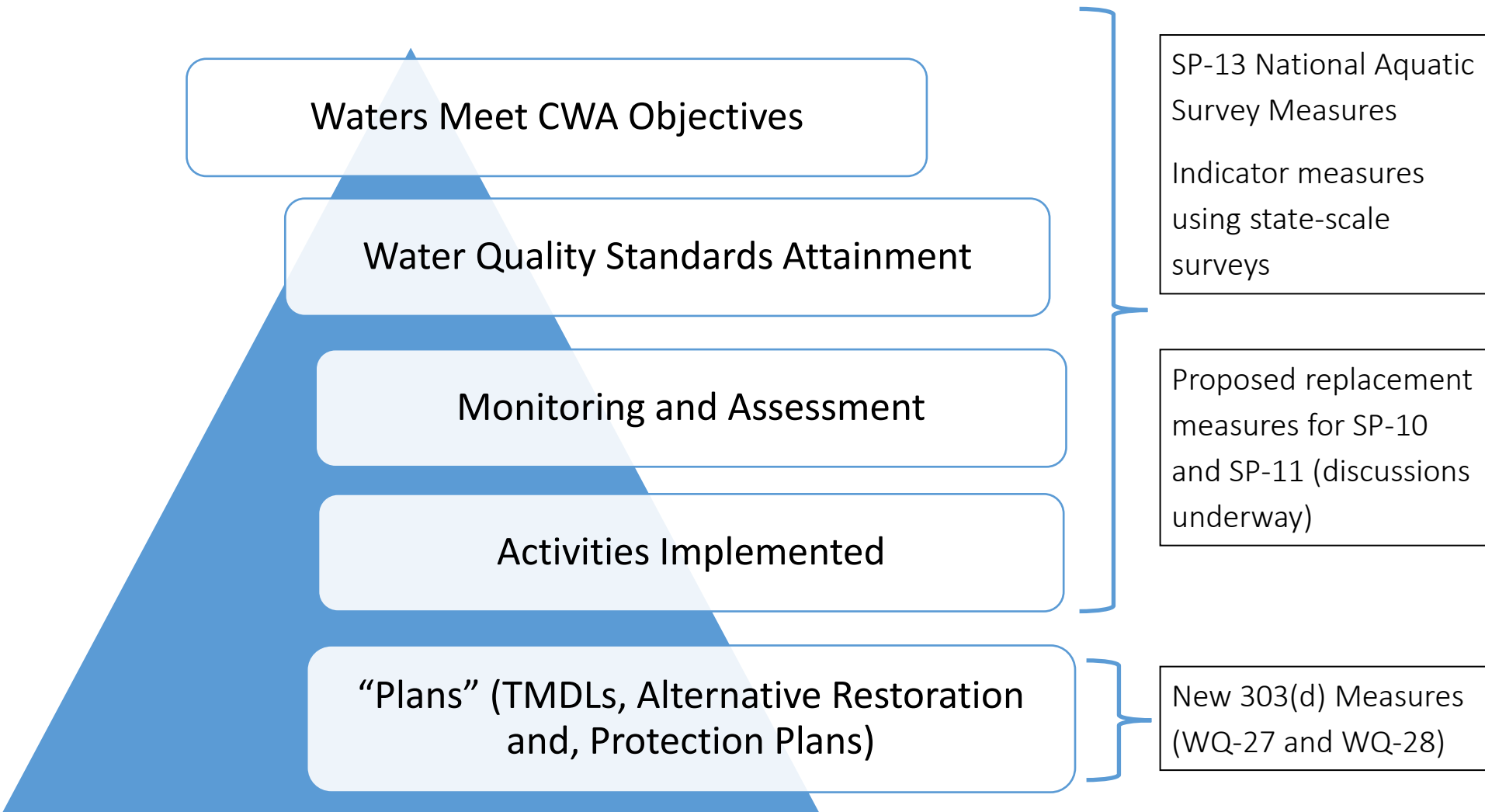

Where we are in the ATTAINS Redesign Effort – Related to Measures

Tool	Status
Tools to automate calculation of measures (for EPA and EPA contractors)	Near complete – demo at meeting in Shepherdstown
Data Entry Tool for Priorities	Draft developed – will begin discussion with Regions and states following this meeting
Data Entry Tool for TMDLs	Use existing National TMDL Tracking System
Data Entry Tool for Alternative and Protection Plans	Discussions will begin this summer with Regions and states
Tool(s) for Regions and states to interact with information being used to calculate the measures	Discussions will begin this summer with Regions and states
Web interface for the public to “see” the measures	Discussions will begin in FY 2016 with Regions and states

Key Actions

- States submit information (data) that outlines “draft” long-term priorities from now to July 2015
- EPA calculates universe and baseline
 - States work with EPA to QA universe and baseline results from now to September 2015
- States work through scenarios for developing “draft commitments” from now to September 2015
- Will form a team of Regions and states to design the new system